

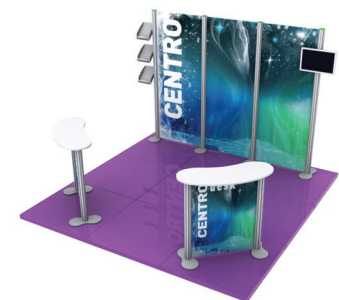

CENTRO[®] DISPLAY KITS

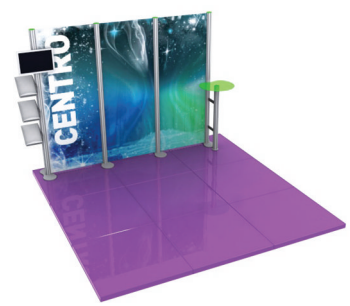

Designed for simple magnetic fixing of your graphic panel.
 Innovative modular display system.
 Contemporary neon acrylic features.
 Unique, robust anodised aluminium construction.
 Requiring only a single hex bit for complete assembly.
 Tool kit supplied.
 Shaped silver base plate to maximise stability.
 Overall height without lighting 2014 mm.
 Quality assured – 12 months guarantee.



This product's system is licensed. PATENT NO: TR 2008 08367 Y

CS1



C1 & CS1 750 mm X 1990 mm

- 2 X Centro Base
- 8 X Centro Base Screw
- 4 X 1000 mm Centro 8 Way Post
- 2 X Post Cap With 2 Screws
- 2 X 750 mm Horizontal Beam-Straight With 1 Run Of Steel Tape
- 4 X 950 mm Vertical Beam-Straight With 1 Run Of Steel Tape
- 8 X Connector Bar with 4 grub screws - 200 mm
- 4 X Expanding Clamp
- 4 X Spacer Sets Incl. 2 Expanding Clamps
- 2 X Baseplate Adjustment Screw

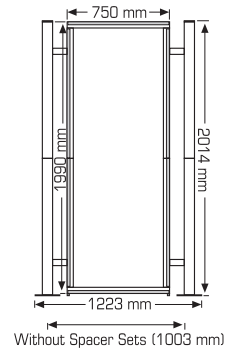

CS2

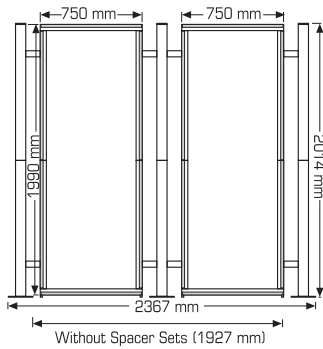

C2 & CS2 (2 X 750 mm) X 1990 mm

- 3 X Centro Base
- 12 X Centro Base Screw
- 6 X 1000 mm Centro 8 Way Post
- 3 X Post Cap With 2 Screws
- 4 X 750 mm Horizontal Beam-Straight With 1 Run Of Steel Tape
- 8 X 950 mm Vertical Beam-Straight With 1 Run Of Steel Tape
- 14 X Connector Bar with 4 Off Grub Screws
- 16 X Expanding Clamp
- 8 X Spacer Sets Incl. 2 Expanding Clamps
- 4 X Baseplate Adjustment Screw

CS3



C3 & CS3 (3 X 750 mm) X 1990 mm

- 4 X Centro Base
- 16 X Centro Base Screw
- 8 X 1000 mm Centro 8 Way Post
- 4 X Post Cap With 2 Screws
- 6 X 750 mm Horizontal Beam-Straight With 1 Run Of Steel Tape
- 12 X 950 mm Vertical Beam-Straight With 1 Run Of Steel Tape
- 20 X Connector Bar with 4 Off Grub Screws
- 12 X Expanding Clamp
- 12 X Spacer Sets Incl. 2 Expanding Clamps
- 6 X Baseplate Adjustment Screw

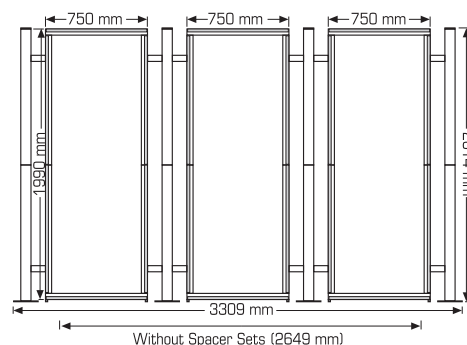

Versatile: You can either choose one of our preconfigured structures or create endless configurations to suit your needs. With its extension bars and locking mechanism it is up to you to decide the height, the width and shape of the units.

Portable: A user friendly system. Very easy to install the system according to the assembly sheet using a single hex key pre supplied in its bag. Easily transported in its own set of carry bags.

Sturdy: Stability is achieved by 75 mm diameter aluminium posts and 6 mm thick galvanized steel base plates.

Elegant: 8-way round posts, stylish base plates, neon acrylic end-caps and innovative accessory range. Elegancy and mobility combined in the same system.

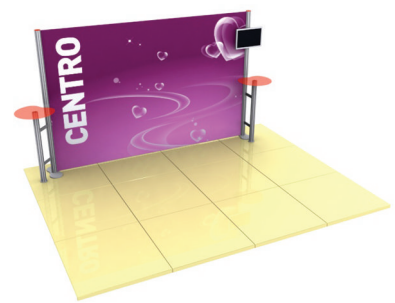



CG2 & CGS2 1500 mm X 1990 mm

- 2 X Centro Base
- 8 X Centro Base Screw
- 4 X 1000 mm Centro 8 Way Post
- 2 X Post Cap With 2 Screws
- 4 X 750 mm Horizontal Beam-Straight With 1 Run Of Steel Tape
- 4 X 950 mm Vertical Beam-Straight With 1 Run Of Steel Tape
- 2 X 950 mm Vertical Beam-Straight With 2 Run Of Steel Tape
- 11 X Connector Bar with 4 grub screws - 200 mm.
- 1 X Connector Bar 4 grub screws and a threaded hole to accommodate adjustable foot - 200 mm.
- 6 X Expanding Clamp
- 4 X Spacer Sets Incl. 2 Expanding Clamps
- 3 X Adjustable Foot For Uneven Floor

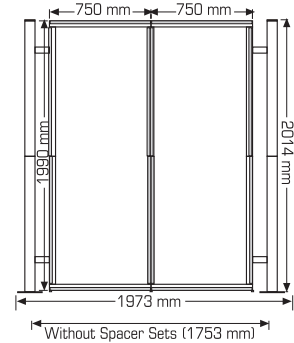

CGS3

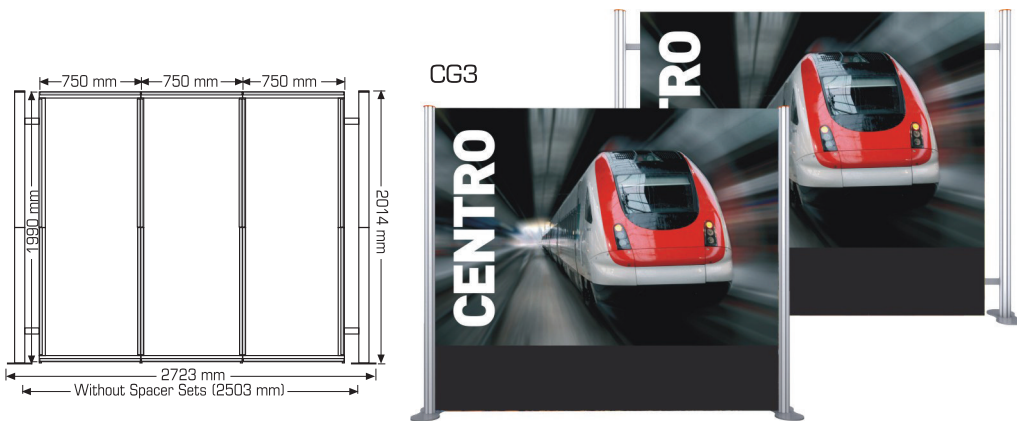

CG3 & CGS3 2250 mm X 1990 mm

- 2 X Centro Base
- 8 X Centro Base Screw
- 4 X 1000 mm Centro 8 Way Post
- 2 X Post Cap With 2 Screws
- 6 X 750 mm Horizontal Beam-Straight With 1 Run Of Steel Tape
- 4 X 950 mm Vertical Beam-Straight With 1 Run Of Steel Tape
- 4 X 950 mm Vertical Beam-Straight With 2 Run Of Steel Tape
- 14 X Connector Bar with 4 grub screws - 200 mm.
- 2 X Connector Bar 4 grub screws and a threaded hole to accommodate adjustable foot - 200 mm.
- 8 X Expanding Clamp
- 4 X Spacer Sets Incl. 2 Expanding Clamps
- 4 X Adjustable Foot For Uneven Floor

CGS4



CG4 & CGS4 3000 mm X 1990 mm

- 2 X Centro Base
- 8 X Centro Base Screw
- 4 X 1000 mm Centro 8 Way Post
- 2 X Post Cap With 2 Screws
- 8 X 750 mm Horizontal Beam-Straight With 1 Run Of Steel Tape
- 4 X 950 mm Vertical Beam-Straight With 1 Run Of Steel Tape
- 6 X 950 mm Vertical Beam-Straight With 2 Run Of Steel Tape
- 17 X Connector Bar with 4 grub screws - 200 mm.
- 3 X Connector Bar 4 grub screws and a threaded hole to accommodate adjustable foot - 200 mm.
- 10 X Expanding Clamp
- 4 X Spacer Sets Incl. 2 Expanding Clamps
- 5 X Adjustable Foot For Uneven Floor

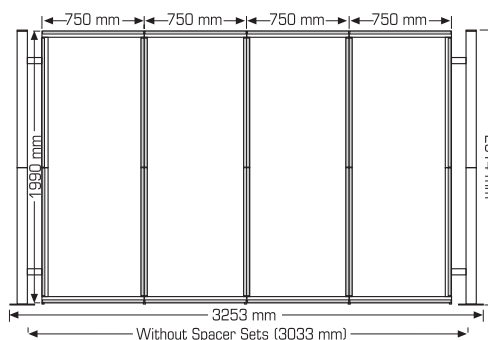



Designed for a visually-seamless magnetic graphic display.
 Innovative modular display system.
 Contemporary neon acrylic features.
 Unique, robust anodised aluminium construction.
 Requiring only a single hex bit for complete assembly.
 Tool kit supplied.
 Shaped silver base plate to maximise stability.
 Overall height without lighting 2014 mm.
 Quality assured – 12 months guarantee.
Extra perspective by curved rails.

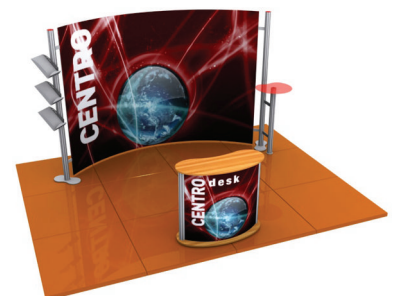
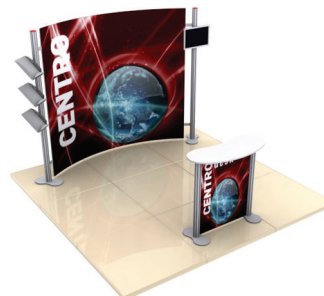
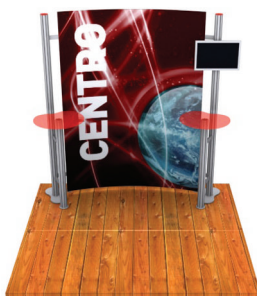
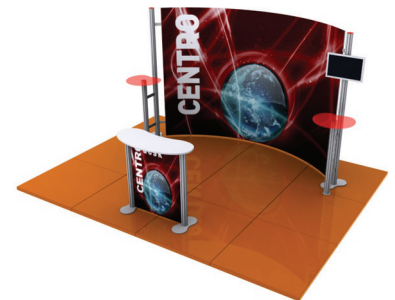
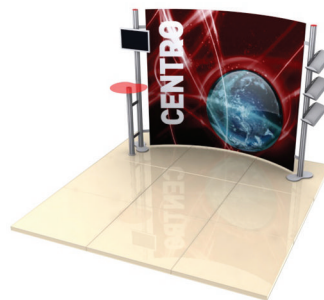
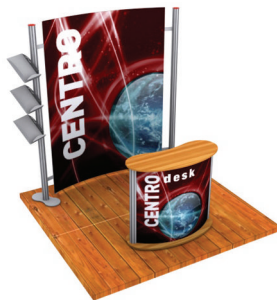



CG2C & CGS2C 1500 mm X 1990 mm

- 2 X Centro Base
- 8 X Centro Base Screw
- 4 X 1000 mm Centro 8 Way Post
- 2 X Neon Post Caps Incl. Screws
- 4 X 750 mm Horizontal-Curved Beam With 1 Run Of Steel Tape
- 4 X 950 mm Vertical Beam-Straight With 1 Run Of Steel Tape
- 2 X 950 mm Vertical Beam-Straight With 2 Run Of Steel Tape
- 10 X Connector Bar with 4 grub screws - 200 mm.
- 1 X Connector Bar with 3 grub screws - 100 mm.
- 3 X Connector Bar 4 grub screws and a threaded hole to accommodate adjustable foot - 200 mm.
- 6 X Expanding Clamp
- 4 X Spacer Sets Incl. 2 Expanding Clamps
- 3 X Adjustable Foot For Uneven Floor

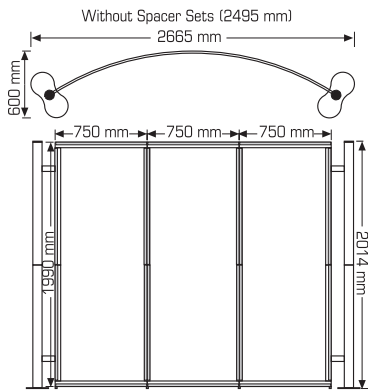
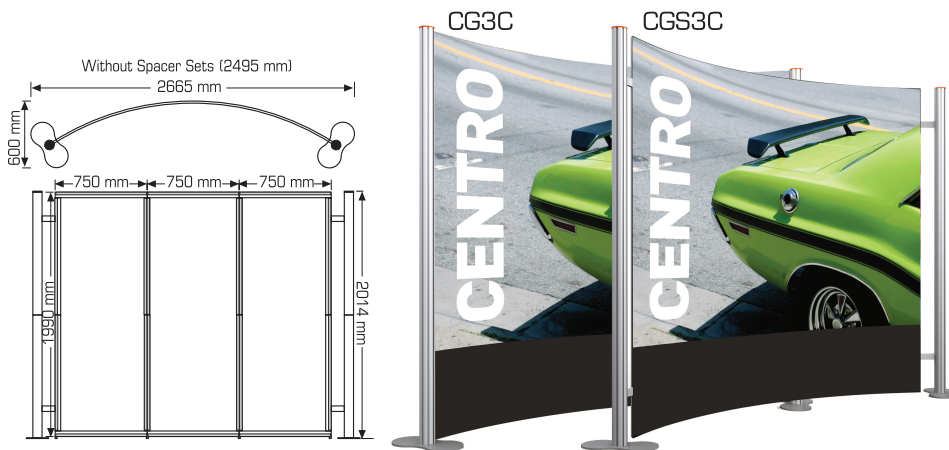
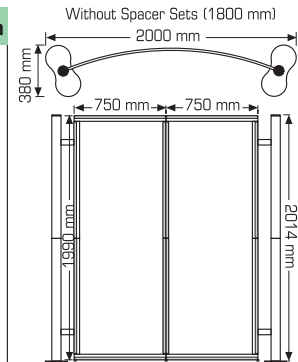

CG3C & CGS3C 2250 mm X 1990 mm

- 2 X Centro Base
- 8 X Centro Base Screw
- 4 X 1000 mm Centro 8 Way Post
- 2 X Neon Post Caps Incl. Screws
- 6 X 750 mm Horizontal Beam-Curved With 1 Run Of Steel Tape
- 4 X 950 mm Vertical Beam-Straight With 1 Run Of Steel Tape
- 4 X 950 mm Vertical Beam-Straight With 2 Run Of Steel Tape
- 12 X Connector Bar with 4 grub screws - 200 mm.
- 2 X Connector Bar with 3 grub screws - 100 mm.
- 4 X Connector Bar 4 grub screws and a threaded hole to accommodate adjustable foot - 200 mm.
- 8 X Expanding Clamp
- 4 X Spacer Bar With 1 Off Expanding Clamps
- 4 X Adjustable Foot For Uneven Floor

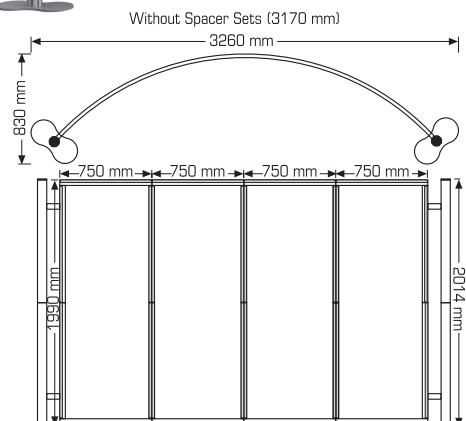

CG4C & CGS4C 3000 mm X 1990 mm

- 2 X Centro Base
- 8 X Centro Base Screw
- 4 X 1000 mm Centro 8 Way Post
- 2 X Neon Post Caps Incl. Screws
- 8 X 750 mm Horizontal Beam-Curved With 1 Run Of Steel Tape
- 4 X 950 mm Vertical Beam-Straight With 1 Run Of Steel Tape
- 6 X 950 mm Vertical Beam-Straight With 2 Run Of Steel Tape
- 14 X Connector Bar with 4 grub screws - 200 mm.
- 3 X Connector Bar 3 grub screws - 100 mm.
- 5 X Connector Bar 2 grub screws and a threaded hole to accommodate adjustable foot - 200 mm.
- 10 X Expanding Clamp
- 4 X Spacer Sets Incl. 2 Expanding Clamps
- 5 X Adjustable Foot For Uneven Floor

Versatile: You can either choose one of our preconfigured structures or create endless configurations to suit your needs. With its extension bars and locking mechanism it is up to you to decide the height, the width and shape of the units.

Portable: A user friendly system. Very easy to install the system according to the assembly sheet using a single hex key pre supplied in its bag. Easily transported in its own set of carry bags.

Sturdy: Stability is achieved by 75 mm diameter aluminium posts and 6 mm thick galvanized steel base plates.

Elegant: 8-way round posts, stylish base plates, neon acrylic end-caps and innovative accessory range. Elegancy and mobility combined in the same system.



Designed for a single banner graphic with horizontally hemmed pockets.
 Innovative modular display system.
 Contemporary neon acrylic features.
 Unique, robust anodised aluminium construction.
 Requiring only a single hex bit for complete assembly.
 4 mm Hex key supplied.
 Shaped silver base plate to maximise stability.
 Quality assured – 12 months guarantee.



CB1



COMPONENTS

CB1 750 mm X 1990 mm

- 2 X Centro Base
- 8 X Centro Base Screw
- 4 X 1000 mm Centro 8 Way Post
- 2 X Neon Post Caps Incl. Screws
- 2 X 750 mm Horizontal Beam-Straight
- 4 X Connector Bar with 4 grub screws - 200 mm
- 4 X Expanding Clamp

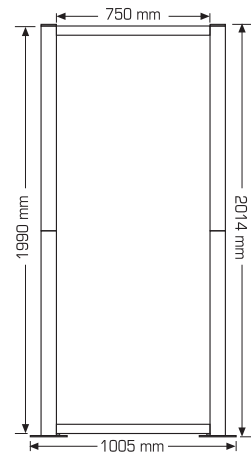

CB2

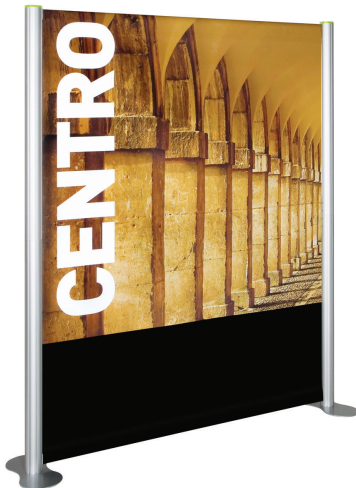

CB2 1500 mm X 1990 mm

- 2 X Centro Base
- 8 X Centro Base Screw
- 4 X 1000 mm Centro 8 Way Post
- 2 X Neon Post Caps Incl. Screws
- 4 X 750 mm Horizontal Beam-Straight
- 6 X Connector Bar with 4 grub screws - 200 mm
- 4 X Expanding Clamp

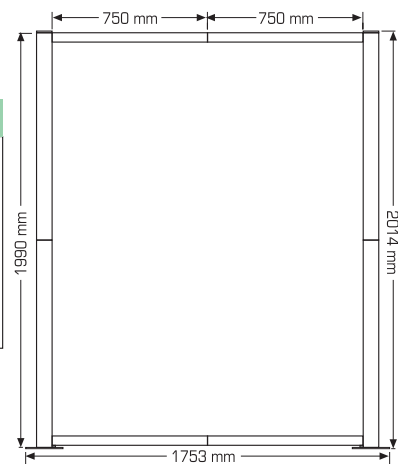

CB3



CB3 2250 mm X 1990 mm

- 2 X Centro Base
- 8 X Centro Base Screw
- 4 X 1000 mm Centro 8 Way Post
- 2 X Neon Post Caps Incl. Screws
- 6 X 750 mm Horizontal Beam-Straight
- 8 X Connector Bar with 4 grub screws - 200 mm
- 4 X Expanding Clamp

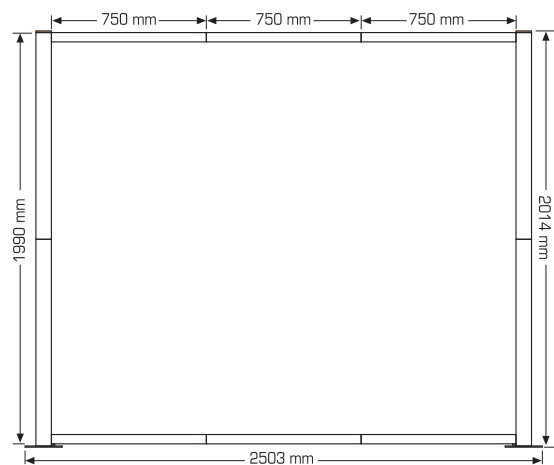



Alternative Layout for CT3

Maximum footprint: 2652 mm W x 1106 mm D

Now, you can stand out in the crowd by our Centro Theatre Display Kits. Innovative modular display system incorporating screens up to 42" with contemporary neon acrylic features.

Unique, robust anodised aluminium construction.

Shaped silver base plate to maximise stability.

Designed to combine an LCD or plasma screen with a visually-seamless magnetic graphic display.

Elegant high-quality anodised aluminium construction.

COMPONENTS

CT1 950 mm X 1990 mm

- 2 X Centro Base
- 8 X Centro Base Screw
- 4 X 1000 mm Centro 8 Way Post
- 2 X Neon Post Caps Incl. Screws
- 4 X 950 mm Horizontal Beam-Straight
- 2 X 1090 mm Vertical Beam-Straight
- 6 X 220 mm Horizontal Beam-Straight
- 12 X 200 mm Connector Bar
- 4 X 260 mm Special Connector Bar and Fixing
- 1 X LCD/Plasma Mounting Set
- 16 X Expanding Clamp
- 1 X Podium Desk Set

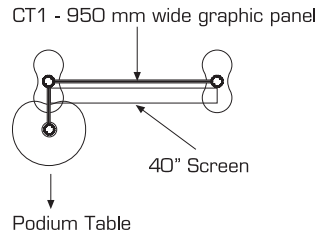

Maximum footprint: 1206 mmW x 521 mmD



CT2 1500 mm X 1990 mm

- 2 X Centro Base
- 8 X Centro Base Screw
- 4 X 1000 mm Centro 8 Way Post
- 2 X Neon Post Caps Incl. Screws
- 8 X 750 mm Horizontal Beam-Straight
- 2 X 1090 mm Vertical Beam-Straight
- 6 X 220 mm Horizontal Beam-Straight
- 20 X 200 mm Connector Bar
- 4 X 260 mm Special Connector Bar and Fixing
- 1 X LCD/Plasma Mounting Set
- 16 X Expanding Clamp
- 1 X Podium Desk Set

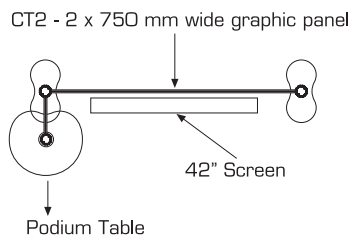

Maximum footprint: 1756 mmW x 521 mmD



C3 & CS3 (3 X 750 mm) X 1990 mm

- 4 X Centro Base
- 16 X Centro Base Screw
- 8 X 1000 mm Centro 8 Way Post
- 4 X Neon Post Caps Incl. Screws
- 8 X 750 mm Horizontal Beam-Straight
- 8 X 950 mm Vertical Beam-Straight
- 6 X 220 mm Horizontal Beam-Straight
- 24 X 200 mm Connector Bar
- 4 X 260 mm Special Connector Bars and Fixings
- 1 X LCD/Plasma Mounting Set
- 32 X Expanding Clamp

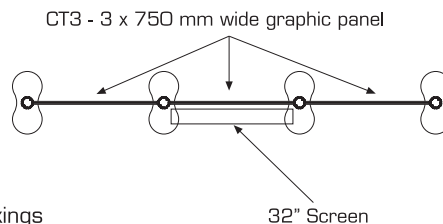

Maximum footprint: 3254 mmW x 380 mmD

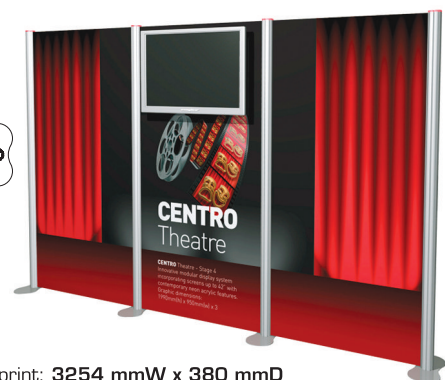

C4 & CS4 (3 X 750 mm) X 1990 mm

- 4 X Centro Base
- 16 X Centro Base Screw
- 8 X 1000 mm Centro 8 Way Post
- 4 X Neon Post Caps Incl. Screws
- 4 X 750 mm Horizontal Beam
- 4 X 750 mm Horizontal Beam (Curved)
- 8 X 950 mm Horizontal Beam-Straight
- 2 X 1090 mm Vertical Beam-Straight
- 6 X 220 mm Horizontal Beam-Straight
- 24 X 200 mm Connector Bar
- 4 X 260 mm Special Connector Bars and Fixings
- 1 X LCD/Plasma Mounting Set
- 32 X Expanding Clamp

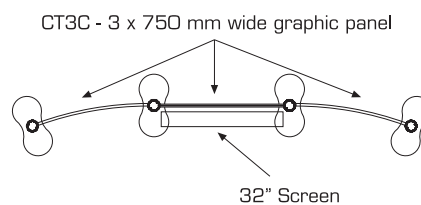

Maximum footprint: 2885 mmW x 518 mmD



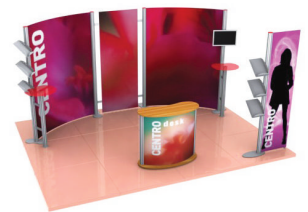
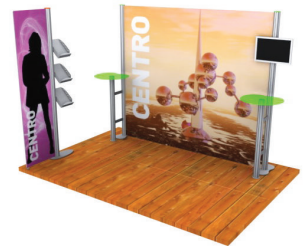
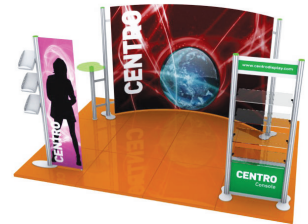

Centro Totem

Designed for simple magnetic fixing of your graphic panel.
500 mm wide x 1990 mm high graphic area.
3 x A4 portrait brochure holders, steel or neon acrylic.
Unique, robust anodised aluminium construction.
Requiring only a single hex key supplied for complete assembly.
Shaped silver base plate to maximise stability.
Quality assured – 12 months guarantee.
Total height 2014 mm.

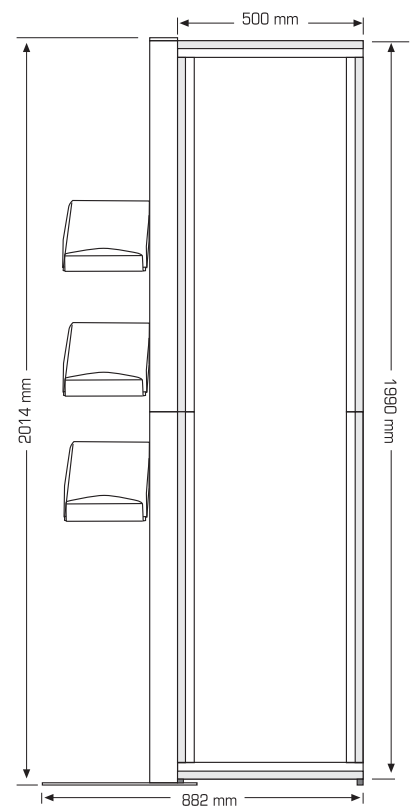
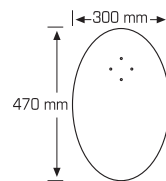

This product's system is licensed. PATENT NO: TR 2008 08367 Y



DESIGNED BY ORES, MAY 2008

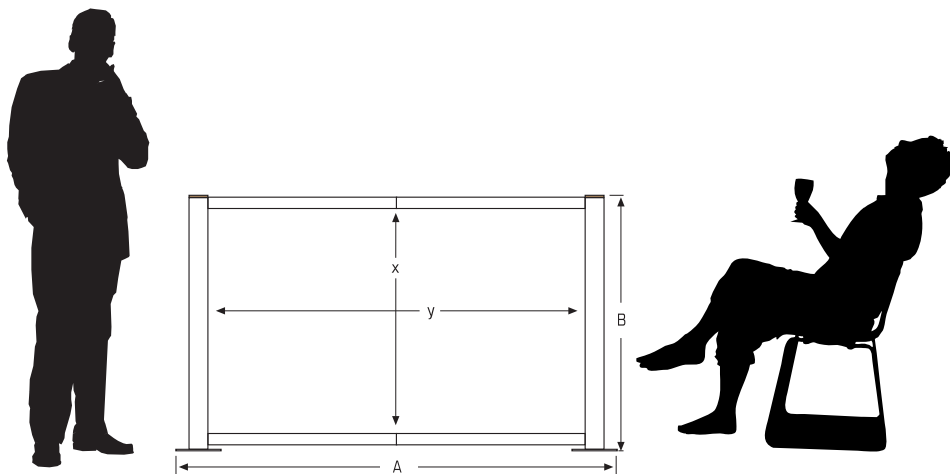

As the specialists in cafe barriers and accessories, we offer CENTRO Barrier systems to cater for every environment and budget. The CENTRO cafe barrier system is a high-end product perfect for restaurants, hotels and outdoor areas and its silver finish and solid bases ensure a long-lasting product. Practical and perfect for almost any location, the CENTRO cafe barrier system is strong, hard-wearing and great value for money. CENTRO barriers in five sizes; 0,75m, 0,95m, 1,5m, 1,9m and 2.25m.

EXTRUSION: Silver color (anodised) aluminium			
ITEM CODE	PANEL SIZES	VISIBLE AREA (y*x)	EXTERNAL SIZE (A*B)
CBR1 075100	765 x 935 mm	734 x 920 mm	1004 x 1014 mm
CBR1 095100	965 x 935 mm	934 x 920 mm	1204 x 1014 mm
CBR2 150100	1515 x 935 mm	1484 x 920 mm	1754 x 1014 mm
CBR2 190100	1915 x 935 mm	1884 x 920 mm	2154 x 1014 mm
CBR3 225100	2265 x 935 mm	2234 x 920 mm	2504 x 1014 mm

This product's system is licensed. PATENT NO: TR 2008 08367 Y

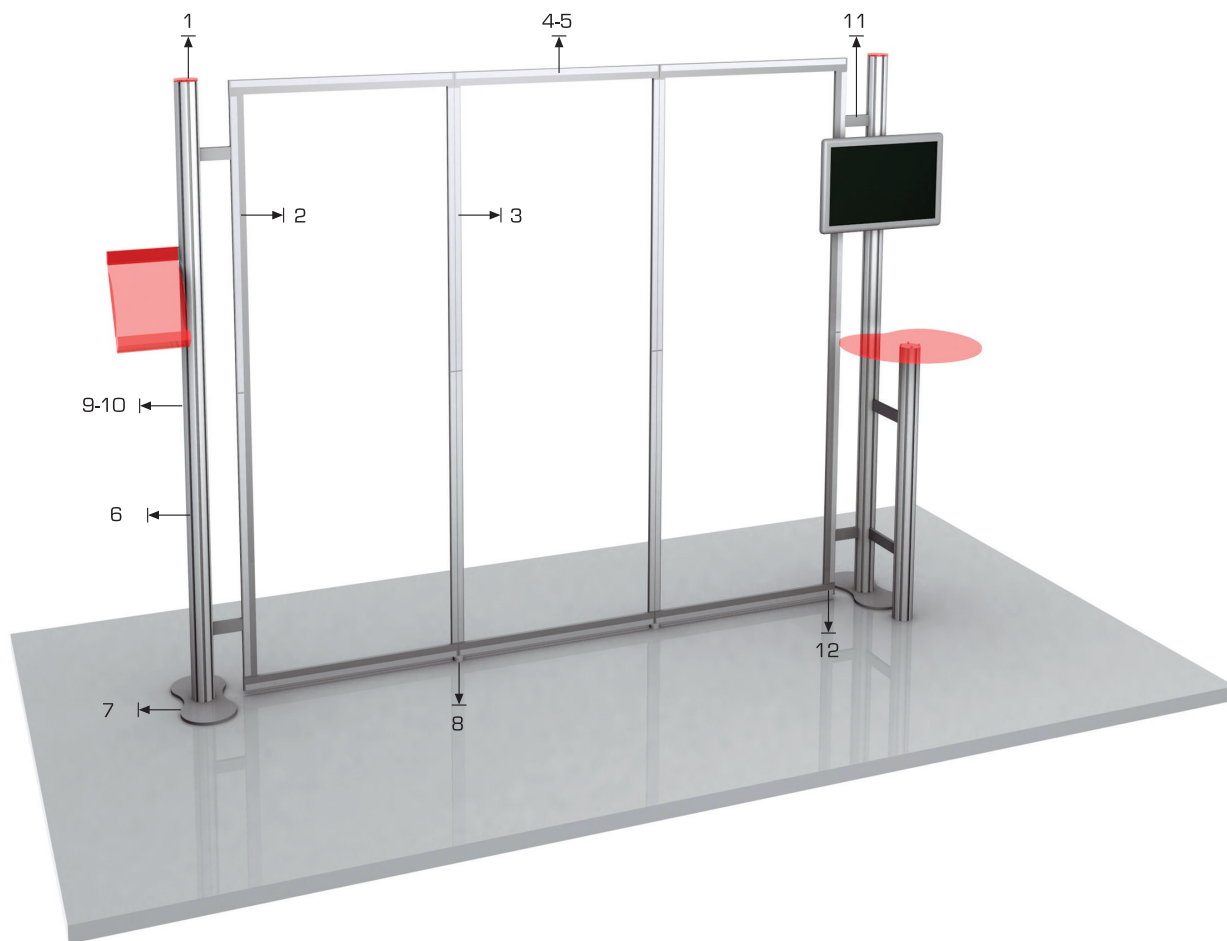

1 Neon acrylic post caps



5 750 mm Horizontal beam (curved)
1 run of steel tape



9 200 mm Connector bar with 4 grub screws



2 950 mm Vertical beam straight with
1 run of steel tape



6 1000 mm Centro 8 way post

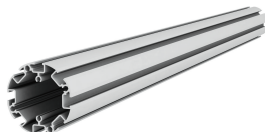

10 200 mm Connector Bar 4 grub screws and a
threaded hole to accommodate adjustable foot



3 950 mm Vertical beam straight with
2 run of steel tape



7 Centro base



11 Spacer bar including 2 expanding clamp



4 750 mm Horizontal beam straight with
1 run of steel tape



8 Adjustment foot for uneven floor



12 Expanding clamp

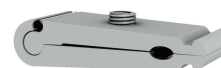

Podium Desk Set

Ergonomically-designed neon acrylic. Available in blue, green and red, or standard frost. Contemporary design to enhance visual impact of modular display system.



LCD Connector

Simple design and uncomplicated assembly with tool supplied. Screen size up to 22" can be fitted to the bracket.



Laptop Shelf

Lightweight robust shelf finished in silver. Supplied with expanding bracket and fixing tool. 400 mm x 280 mm.

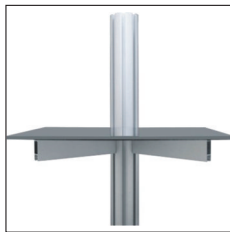

Spot Light

50 watt silver spotlight. 220 volt, Flexible head design. Plastic peg style fastener. European plug and on off switch.



Brochure Holder - Neon

Available in blue, green and red, or standard frost. Thermoformed one piece acrylic to maximise strength. Simple hook over style fitting.



Brochure Holder - Steel

Powder coated steel A4 portrait brochure holder. Available in grey finish, perfect match with aluminium. Fitted to the Centro system post with connector bars (included in box).

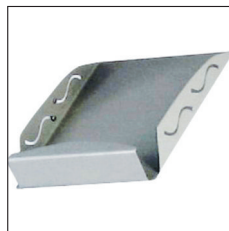

Centro Trolley Bag

Compact and durable
Wheeled base
Overall size
560 mm x 1330 mm x 270 mm



Centro Graphic Bag

Hard bag to protect your graphics.



ENDLESS CONFIGURATIONS TO CREATE YOUR OWN EXHIBITION STAND

