

NOTICEBOARDS

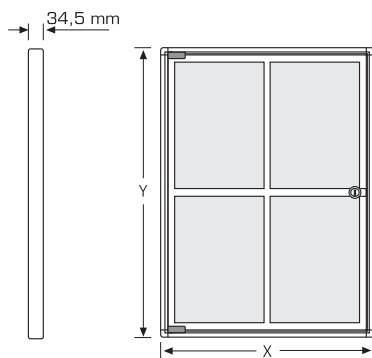

Internal, economy magnetic lockable notice board.
 Practical - perfect for use in an office for memo's and notices
 Silver anodised aluminium frame with gray plastic safety corners.
 Manufactured with galvanized steel, powder coated white finish backplate,.
 Lockable hinged door.
 4 mm unbreakable acrylic door, or 4mm toughened glass.
 Round corners due to the innovative design.
 Suitable for internal use.

EXTRUSION: Silver color (anodised) aluminium

ITEM CODE	CAPACITY	VISIBLE AREA	EXTERNAL SIZE (Y*X)	LOCK
SNBS Y1 D1	1 A4	230 x 320 mm	280 x 370 mm	1
SNBS Y2 D1	2 A4	450 x 320 mm	500 x 370 mm	1
SNBS Y3 D1	3 A4	670 x 320 mm	720 x 370 mm	1
SNBS Y2 D2	4 A4	450 x 630 mm	500 x 680 mm	2
SNBS Y3 D2	6 A4	670 x 630 mm	720 x 680 mm	2
SNBS Y4 D2	8 A4	890 x 630 mm	940 x 680 mm	2

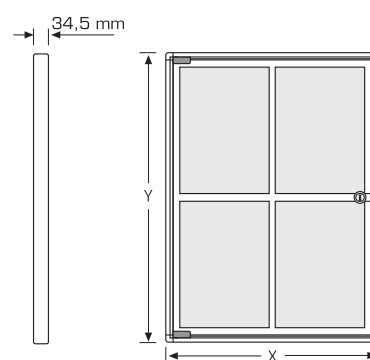
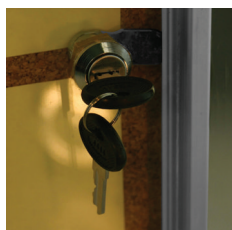

EXTRUSION: Silver color (anodised) aluminium				
ITEM CODE	CAPACITY	VISIBLE AREA	EXTERNAL SIZE (Y*X)	LOCK
SNBM Y1 D1	1 A4	230 x 320 mm	280 x 370 mm	1
SNBM Y2 D1	2 A4	450 x 320 mm	500 x 370 mm	1
SNBM Y3 D1	3 A4	670 x 320 mm	720 x 370 mm	1
SNBM Y2 D2	4 A4	450 x 630 mm	500 x 680 mm	2
SNBM Y3 D2	6 A4	670 x 630 mm	720 x 680 mm	2
SNBM Y4 D2	8 A4	890 x 630 mm	940 x 680 mm	2

Internal, economy cork lockable notice board. Practical - perfect for use in an office for memo's and notices. Silver anodised aluminium frame with gray plastic safety corners. Manufactured with natural cork back wall for use with pins. Lockable hinged door. 4mm unbreakable acrylic door, or 4mm toughened glass. Round corners due to the innovative design. Suitable for internal use.

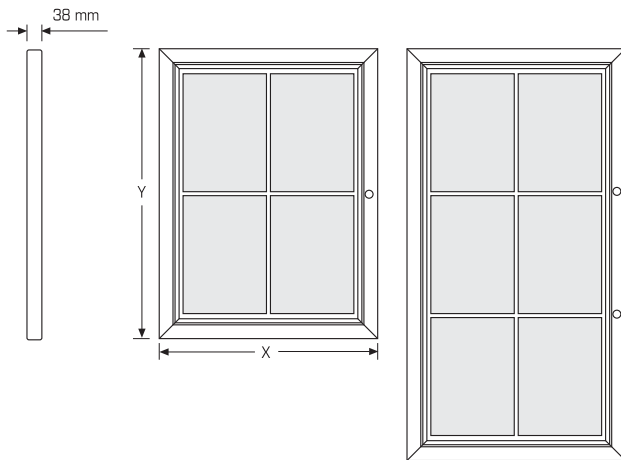
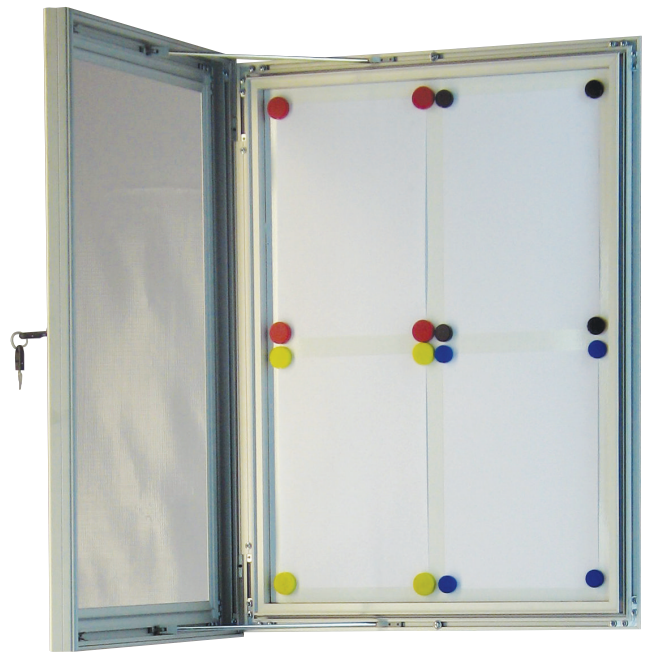
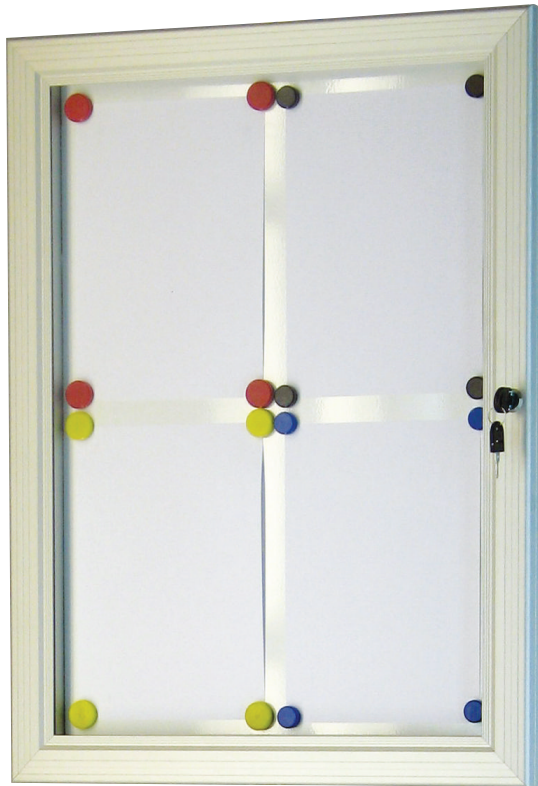

Suitable for indoor and outdoor use.
 Weather resistant.
 Hinged door opens 90 degrees
 (with stays to keep the door open while changing posters)
 1 or 2 locks according to size plus KEYS to lock.
 Frame 45mm wide. 38mm deep (external).
 Silver-anodised (standard) - RAL Colors - powder coated
 finish aluminium frame is also available.
 Galvanized steel, powder coated white finish backplate,
 Strong plastic front face (3mm).
 Can be used in both portrait and landscape positions.

EXTRUSION: Silver color (anodised) aluminium

ITEM CODE	CAPACITY	VISIBLE AREA	EXTERNAL SIZE (Y*X)	LOCK
NBS Y1 D1	1 A4	250 x 340 mm	328 x 418 mm	1
NBS Y1 D2	2 A4	250 x 660 mm	328 x 738 mm	1
NBS Y1 D3	3 A4	250 x 980 mm	328 x 1058 mm	1
NBS Y2 D1	2 A4	480 x 340 mm	558 x 418 mm	1
NBS Y2 D2	4 A4	480 x 660 mm	558 x 738 mm	1
NBS Y2 D3	6 A4	480 x 980 mm	558 x 1058 mm	1
NBS Y3 D1	3 A4	710 x 340 mm	788 x 418 mm	2
NBS Y3 D2	6 A4	710 x 660 mm	788 x 738 mm	2
NBS Y3 D3	9 A4	710 x 980 mm	788 x 1058 mm	2
NBS Y3 D4	12 A4	710 x 1300 mm	788 x 1378 mm	2
NBS Y4 D2	8 A4	940 x 660 mm	1018 x 738 mm	2
NBS Y4 D3	12 A4	940 x 980 mm	1018 x 1058 mm	2

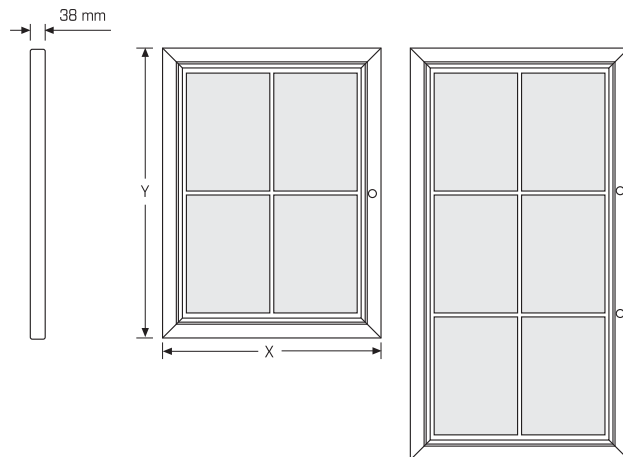
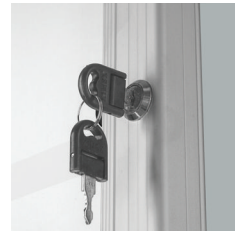
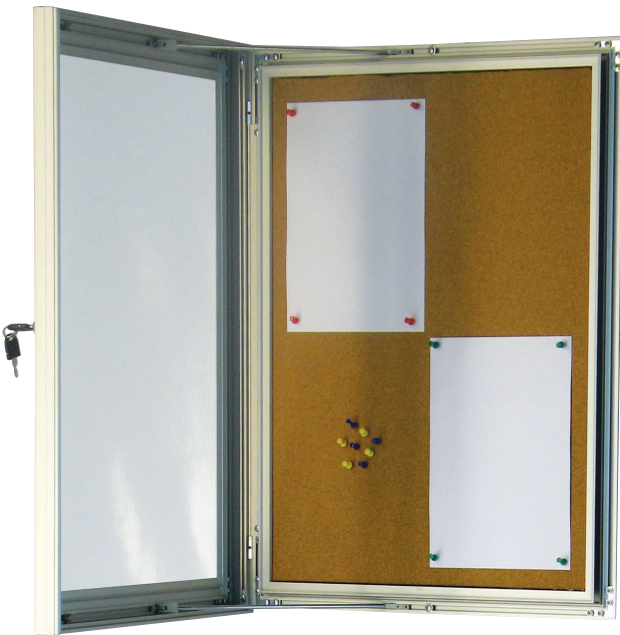
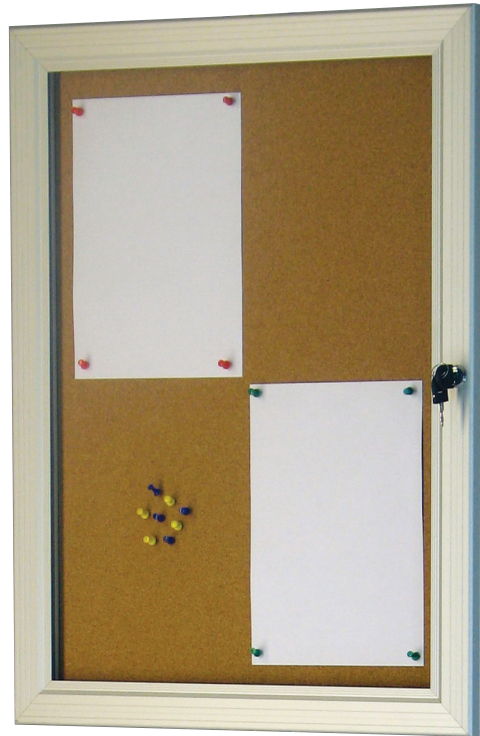

EXTRUSION: Silver color (anodised) aluminium

ITEM CODE	CAPACITY	VISIBLE AREA	EXTERNAL SIZE (Y*X)	LOCK
NBM Y1 D1	1 A4	250 x 340 mm	328 x 418 mm	1
NBM Y1 D2	2 A4	250 x 660 mm	328 x 738 mm	1
NBM Y1 D3	3 A4	250 x 980 mm	328 x 1058 mm	1
NBM Y2 D1	2 A4	480 x 340 mm	558 x 418 mm	1
NBM Y2 D2	4 A4	480 x 660 mm	558 x 738 mm	1
NBM Y2 D3	6 A4	480 x 980 mm	558 x 1058 mm	1
NBM Y3 D1	3 A4	710 x 340 mm	788 x 418 mm	2

Suitable for indoor and outdoor use.
 Weather resistant.
 Hinged door opens 90 degrees
 (with stays to keep the door open while changing posters)
 1 or 2 locks according to size plus KEYS to lock.
 Frame 45mm wide. 38mm deep (external).
 Silver-anodised (standard) - RAL Colors - powder coated
 finish aluminium frame is also available.
 Manufactured with natural cork back wall for use with pins.
 Strong acrylic front face (3mm)
 Can be used in both portrait and landscape positions.

MAGNETIC BOARD – DYNAMIC

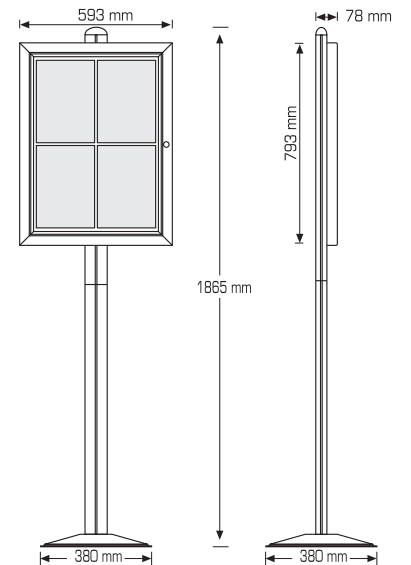
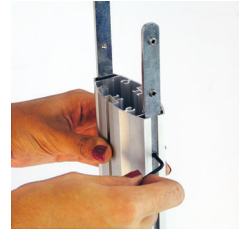
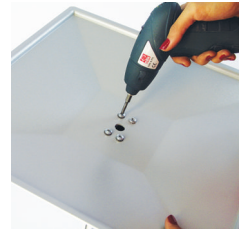

Single pedestal display unit.
 4 way post extrusion enabling different configurations.
 Weather resistant
 Silver anodised aluminium frame and post.
 Lockable hinged front with acrylic safety glass.
 Galvanized steel, powder coated white finish backplate,
 Stable with 380 x 380 mm steel base.
 Two pieces post saving space during transport.

EXTRUSION: Silver color (anodised) aluminium				
ITEM CODE	CAPACITY	POSTER AREA	EXTERNAL SIZE	LOCK
DS NBS Y2 D2	4 A4	480 x 660 mm	558 x 738 mm	1
DS NBS Y2 D3	6 A4	480 x 980 mm	558 x 1058 mm	1

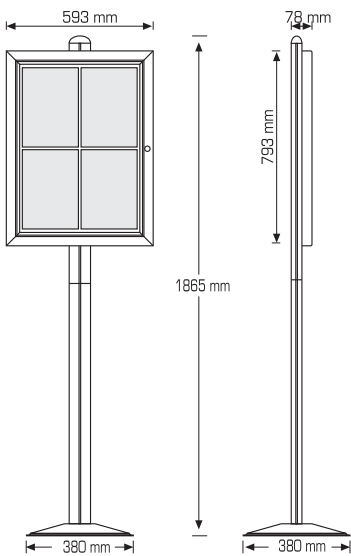
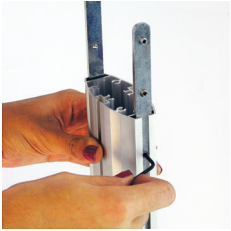

Single pedestal display unit.
 4 way post extrusion enabling different configurations.
 Weather resistant
 Silver anodised aluminium frame and post.
 Lockable hinged front with acrylic safety glass.
 3 mm thick cork backing,
 Stable with 380 x 380 mm steel base.
 Two pieces post saving space during transport.

EXTRUSION: Silver color (anodised) aluminium				
ITEM CODE	POSTER AREA	VISIBLE AREA	EXTERNAL SIZE	CAPACITY
DS NBM 050070	500 x 700 mm	422 x 622 mm	593 x 793 mm	4 A4

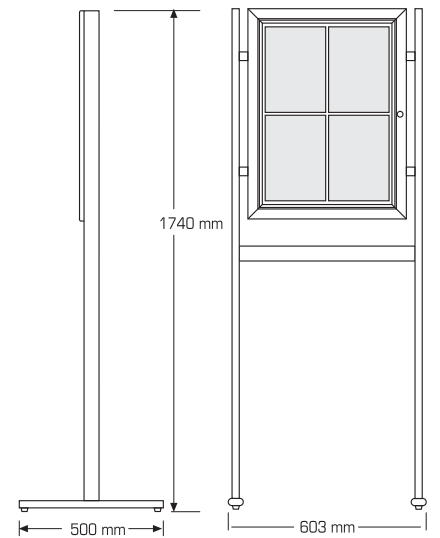
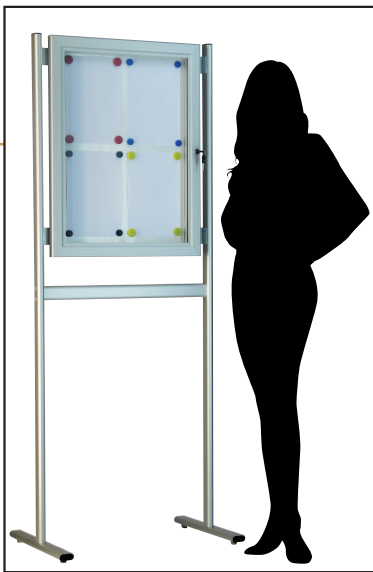

Free standing display unit.
 High quality product for promotional posters, notices or menus etc.
 Weatherproof. Suitable for internal or external use.
 Easy image change. Easy to install.
 Key locks for security.
 Resilient acrylic front face (3mm), for image protection.
 Galvanized steel, powder coated white finish backplate,

EXTRUSION: Silver color (anodised) aluminium

ITEM CODE	CAPACITY	VISIBLE AREA	EXTERNAL SIZE	LOCK
PS NBS Y2 D2	4 A4	480 x 660 mm	558 x 738 mm	1
PS NBS Y2 D3	6 A4	480 x 980 mm	558 x 1058 mm	1

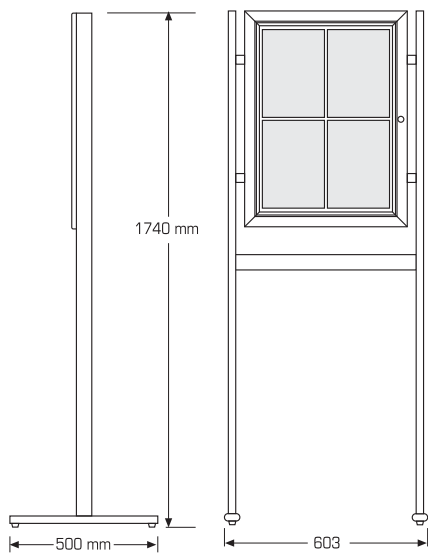

EXTRUSION: Silver color (anodised) aluminium

ITEM CODE	CAPACITY	VISIBLE AREA	EXTERNAL SIZE	LOCK
PS NBM Y2 D2	4 A4	480 x 660 mm	558 x 738 mm	1
PS NBM Y2 D3	6 A4	480 x 980 mm	558 x 1058 mm	1

Free standing display unit.
 High quality product for promotional posters, notices or menus etc.
 Weatherproof. Suitable for internal or external use.
 Easy image change. Easy to install.
 Key locks for security.
 Resilient acrylic front face (3mm), for image protection.
 Manufactured with natural cork back wall for use with pins.

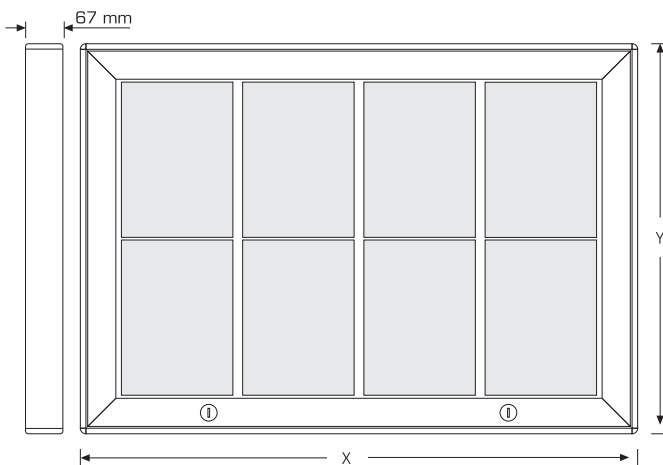
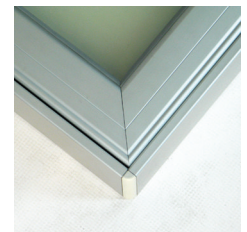
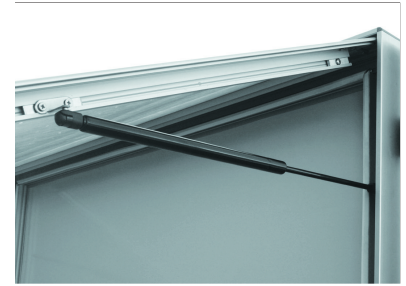

Heavy Duty, secure system bulletin board,
 Strong waterproof construction and vandal resistant.
 Warp proof integral hinge.
 Ideal for external locations.
 Silver anodized aluminium framed Notice Boards
 for outdoor use
 Waterproof elastomer seal.
 4 mm toughened glass safety front face.
 Coated steel back wall suitable for magnets to hold
 documents in place.
 Larger sizes above 12 x A4 having gas strut opening.
 Suitable for internal and external use.
 67 mm depth.
 Rondo corners due to the innovative design.

EXTRUSION: Silver color (anodised) aluminium

ITEM CODE	CAPACITY	POSTER AREA	EXTERNAL SIZE (X*Y)	LOCK
BNB TC Y3 D3	9 A4	660 x 930 mm	790 x 1062 mm	1
BNB TC Y4 D2	8 A4	880 x 620 mm	1000 x 752 mm	2
BNB TC Y4 D3	12 A4	880 x 930 mm	1000 x 1062 mm	2
BNB TC Y5 D2	10 A4	1100 x 620 mm	1230 x 752 mm	2
BNB TC Y5 D3	15 A4	1100 x 930 mm	1230 x 1062 mm	2
BNB TC Y6 D3	18 A4	1320 x 930 mm	1450 x 1062 mm	2
BNB TC Y7 D3	21 A4	1540 x 930 mm	1670 x 1062 mm	2
BNB TC Y8 D3	24 A4	1760 x 930 mm	1773 x 1062 mm	2
BNB TC Y9 D3	27 A4	1980 x 930 mm	2110 x 1062 mm	2